

Technical
Drawing

Desenho
Técnico

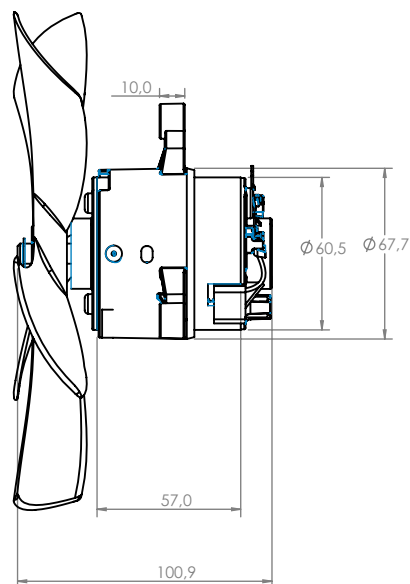
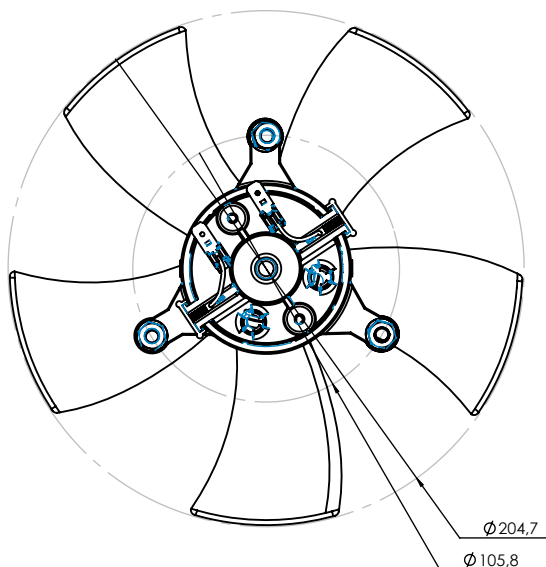

Technical
Specification

Especificação
Técnica

Imagem
Ilustrativa

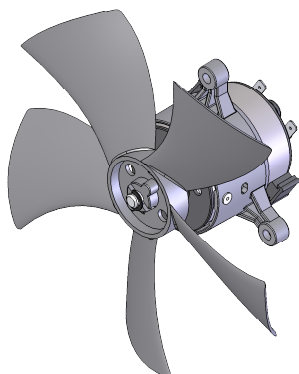

101322312

Valores Nominais	
Tensão (V)	13
Corrente (A)	2,2
RPM (min ⁻¹)	2530
Vazão (m ³ /h)	613
Peso (Kg)	1,000

101322324

Valores Nominais	
Tensão (V)	27
Corrente (A)	2,6
RPM (min ⁻¹)	2900
Vazão (m ³ /h)	613
Peso (Kg)	1,000

-Aspirante

-Suction